

ClearOne®

COLLABORATE® Versa Lite CT





Contents

Important Safety Information.....	3
Introduction	4
Basic Versa Lite Connections.....	4
Operating and System Requirements	5
Setup.....	6
Step 1: Unpack	6
Step 2: Install/Mount the Components.....	6
Step 3: Connect the Components	9
Step 4: Start and Test the System.....	11
Step 5: Adjust the System.....	11
COLLABORATE Space Pro	11
Pair a Bluetooth Device	12
Troubleshooting	13
Compliance.....	13
ClearOne Contacts.....	13

Important Safety Information

1. Read and follow all instructions.
2. Keep these instructions.
3. Do not use these devices near water.
4. Clean only with dry cloth.
5. Do not block any ventilation openings. Install in accordance with manufacturer instructions.
6. Do not install near any heat sources such as radiators, heat registers, stoves, or other apparatus (including amplifiers) that produce heat.
7. Do not defeat the safety purpose of the polarized or grounding-type plug. A polarized plug has two blades with one wider than the other. A grounding type plug has two blades and a third grounding prong. The wide blade or the third prong are provided for your safety. If the provided plug does not fit into your outlet, consult an electrician for replacement of the obsolete outlet.
8. Protect the PoE injector's power cord from being walked on or pinched particularly at plugs, convenience receptacles, and the point where they exit from the apparatus.
9. Only use attachments/accessories specified by the manufacturer.
10. When a cart is used, use caution when moving the cart/apparatus combination to avoid injury from tip-over.
11. Unplug this apparatus during lightning storms or when unused for long periods of time.
12. Refer all servicing to qualified service personnel. Servicing is required when the apparatus has been damaged in any way, such as power-supply cord or plug is damaged, liquid has been spilled or objects have fallen into the apparatus, the apparatus has been exposed to rain or moisture, does not operate normally, or has been dropped.
13. Disconnect the apparatus from the AC mains with the mains plug. This plug shall remain readily operable.
14. Never push objects of any kind into this product through cabinet slots as they may touch dangerous voltage points or short out parts that could result in fire or electric shock.
15. This product can interfere with electrical equipment such as tape recorders, TV sets, radios, computers and microwave ovens if placed in close proximity.
16. Class 2 Wiring IS REQUIRED. Only qualified personnel should wire and install.
17. Underwriters Laboratories (UL) requires these safety notifications:

WARNING: TO PREVENT FIRE OR ELECTRICAL SHOCK HAZARD, DO NOT EXPOSE THIS PRODUCT TO RAIN OR MOISTURE

	CAUTION	
THE LIGHTING FLASH AND ARROWHEAD WITHIN THE TRIANGLE IS A WARNING SIGN ALERTING YOU OF DANGEROUS VOLTAGE INSIDE THE PRODUCT.	RISK OF ELECTRIC SHOCK DO NOT OPEN AVIS RISQUE DU CHOC ELECTRIQUE - NE PAS OUVRIR CAUTION: TO REDUCE THE RISK OF ELECTRIC SHOCK, DO NOT REMOVE COVER (OR BACK) NO USER SERVICEABLE PARTS INSIDE. REFER SERVICING TO QUALIFIED SERVICE PERSONNEL.	THE EXCLAMATION POINT WITHIN THE TRIANGLE IS A WARNING SIGN ALERTING YOU OF IMPORTANT INSTRUCTIONS ACCOMPANYING THE PRODUCT.
SEE MARKING ON BOTTOM/BACK OF PRODUCT		

 Use only in non-tropical locations.

 Use only at altitudes of 2000 meters or less.

Introduction

The COLLABORATE Versa Lite CT brings cost-effective and superb professional conferencing to small- and mid-sized meeting rooms.

The Versa Lite CT features a BMA CTH, a USB audio enabled Beamforming Ceiling Tile Microphone that includes:

- 24 microphones, configurable in 2 patterns (5 or 6 beams).
- Acoustic Echo Cancellation (AEC)
- 2x10 Watt Power amps

Also included in the Versa Lite CT are the following:

- COLLABORATE Versa USB
- A compatible PoE Injector
- All necessary interconnecting cables
- 90-day subscription to COLLABORATE Space Pro Cloud-based Service

The entire system can be configured with ClearOne's CONSOLE AI Lite software with Audio Intelligence™ and AutoConnect™.

The diagram to the right illustrates a typical Versa Lite CT installation.

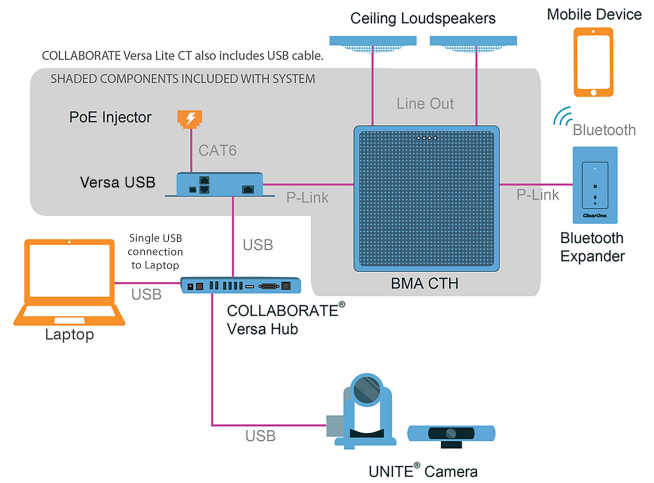

Basic Versa Lite Connections

The steps listed below and the accompanying illustration describe how to connect your Versa Lite.

1. Connect the PoE injector to the Versa USB PoE In port.
2. On the Versa USB, move the Power Select switch to the PoE In position.
3. Connect the Versa USB P-Link Out port to the BMA CTH P-Link In port.
4. On the BMA CTH, move the Power Select switch to the P-Link In position.
5. Connect the Versa USB Audio port to your computer's USB port.

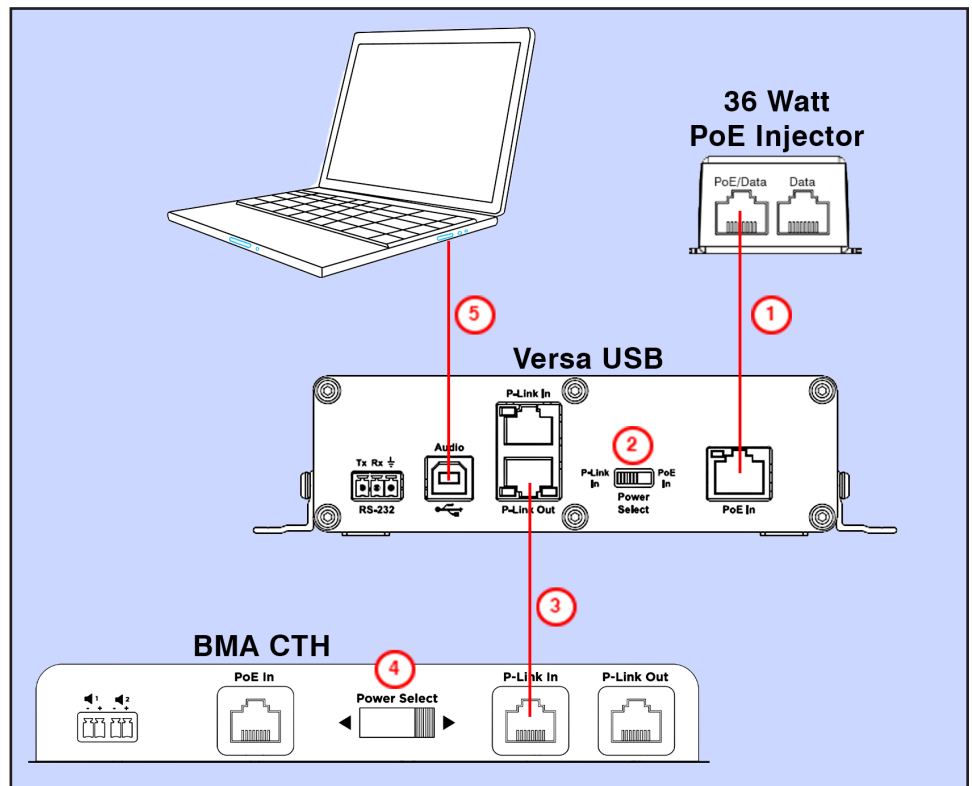

Important details related to installation, testing, and troubleshooting are provided in the following sections.

Optional ClearOne Peripherals

The following components are available to enhance your system:

- UNITE® 50 4k EPTZ Camera
- UNITE® 150 PTZ Camera
- CONVERGE® Wall-Mount Bluetooth Expander
- COLLABORATE® Versa Hub

Operating and System Requirements

System Power and Thermal

- Power Type: PoE/PoE+
- Port Type: RJ-45
- PoE In: 802.3af or 802.3at PoE/PoE+
- Power Source: PoE Injector or equivalent
- PoE: IEEE 802.3at compliant devices providing 56V and 640 mA (36 W).
- P-Link In - Mode B
- Power Consumption:
 - 100-240VAC, 50/60Hz, 3 Watts Typical
 - 38W at max power 1kHz (2 x 10W)
 - Thermal: 130 BTU/Hr at max power
- Operating Temperature: 14° F/-10° C to 104° F/40° C ambient temperature

Supported Operating Systems

- Windows 8, Windows 10

Minimum System Requirements

- Intel or AMD 6 with 1GHz or higher recommended
- 2GB RAM (or higher recommended)
- 500MB hard disk space (additional space is required to store site files and other project files)
- Administrator permission to install and run the software

System Part Number

- COLLABORATE Versa Lite CT: 930-3200-010
- COLLABORATE Versa Lite CT INTERNATIONAL: 930-3200-010-I

Setup

Step 1: Unpack

Verify that you have received all parts associated with each of the components.

Inspect your shipment carefully. If the shipment shows obvious signs of damage, retain original boxes and packing material for inspection by the carrier, and contact them immediately. ClearOne is not responsible for product damage incurred during shipment.

BMA CTH

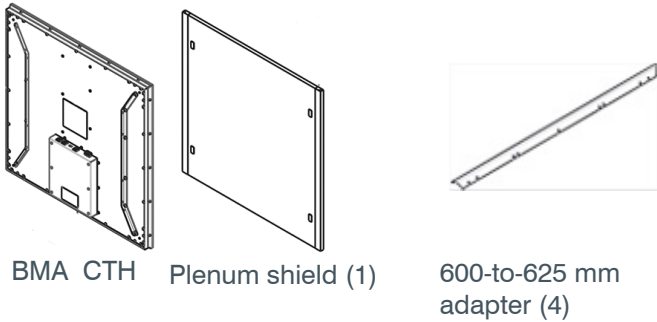

COLLABORATE Versa USB



PoE Kit (Injector)



Cables



Step 2: Install/Mount the Components

BMA CTH

On the BMA CTH back panel

- With speaker wire (not included), connect external speakers to the Phoenix Euroblock connectors (a)
- Move the Power Select sliding switch (c) to the right, towards the P-Link In connector (d)

Prepare Plenum Shield for Seismic Cables

If you plan to install both the plenum shield and seismic cables:

Cut four 1" long slots diagonally in the plenum shielding to match the points of seismic cable attachment.

If you do not plan to install the plenum shield and cables, skip this step.

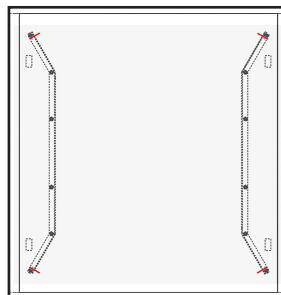

Attach the Plenum Shield to the BMA CTH

1. On the underside of the shield, remove the liner from the adhesive in four places.
2. Thread cables through cut slots before you attach to ceiling.

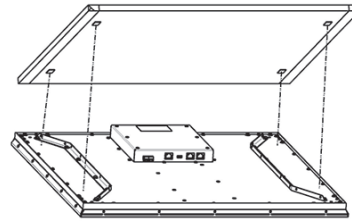

Install the BMA CTH with Seismic Cables

You can mount the BMA CTH in a suspended ceiling, held in place by the standard T-BAR grid, with an additional 1/8" diameter seismic cables (not included).

For stability, ClearOne recommends attachment at the four points shown. If installing with the plenum shield, feed cables thru slots cut in earlier step

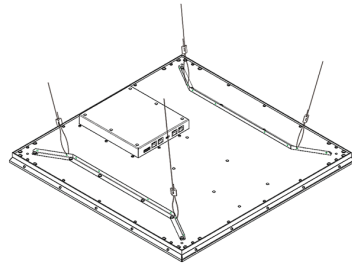

COLLABORATE Versa USB

You can mount the Versa USB in the following ways:

- a rack shelf
- under the table
- on the wall
- above the ceiling

Mounting hardware is not included.

The following parts are not included with the Versa USB:



Tools Required

The following tools are required to install the Versa USB:

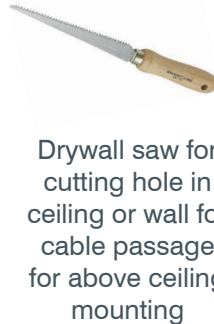

Rack Shelf Mount

ClearOne offers a standard 1U rack shelf with 20lb (9kg) weight capacity.

1. Determine location for rack shelf.
2. Align mounting holes on rack shelf mounting ears with holes on the rack (at determined location).
3. Insert the four #10-32 screws included with the ClearOne 1U rack shelf (or proper screws for your third-party mount) and tighten.

Note: Remove pre-installed mounting ears on expander to fit up to 3 expander units side-by-side on a single ClearOne 1U rack shelf.

4. Torx drive screws secure the pre-installed mounting ears to the main body of the expander unit. Remove them with a Torx T15 screwdriver. (optional)
5. Secure expander unit(s) to the rack shelf. You must supply your own hardware (four #6 or M3.5 screws) for securing the expander(s).

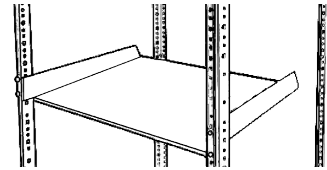
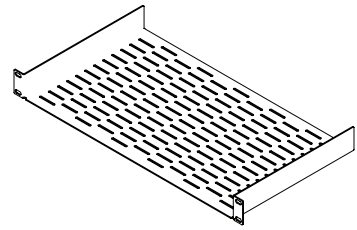

Under-the-Table Mount

1. Select your hardware based on your specific installation needs.
2. Determine location for the mount.
3. Using expander as a guide (and level if needed), mark four mounting hole locations with a pencil.
4. Determine proper depth and diameter, and drill four pilot holes for the #6 or M3.5 screws.
5. Align mounting holes on expander mounting ears with pilot holes.
6. Insert four #6 or M3.5 screws and tighten
7. Align mounting holes on expander mounting ears with pilot holes.
8. Insert four #6 or M3.5 screws and tighten.

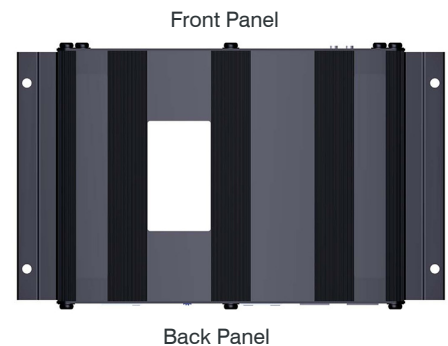

Wall Mount

Mounting hardware is not provided. Select your own hardware based on your specific installation needs.

1. Determine location for the mount.
2. Using expander as a guide (and level if needed), mark four mounting hole locations with a pencil.
3. Drill four pilot holes for fasteners/anchors using proper size drill bits.
4. Install fasteners/anchors.
5. Align mounting holes on expander mounting ears with pilot holes.
6. Insert four #6 or M3.5 screws and tighten.

Note: Anchors and screws to mount the expander are not provided. The installer must select them for the wall material that supports the expander. Exercise care when you drill and install anchors so wall material does not tear out and weaken the attachment.

Above The Ceiling

Select hardware based on your specific installation needs.

Note: It is the installer's responsibility to ensure that the installation and cable routing complies with local safety codes.

1. Determine location for the mount, and where to route cables.
Mark location where you want to route cables through with a pencil (on finished side of ceiling tile) if you need to cut a hole.
2. Remove affected ceiling tile and adjacent tiles required for access.
3. Install fasteners/anchors.
4. Install expander unit at determined location.
5. Use drywall saw to cut hole into finished side of ceiling tile at marked location.

6. Route the cables through the hole.

Note the following:

- Carefully run connected cables so they do not block the cooling vents or put strain on the connectors.
- Anchors and screws used to mount the expander are not provided and must be selected by installer for the type of ceiling material supporting the expander. Take care while drilling and installing anchors so ceiling material does not tear out and weaken attachment.

Step 3: Connect the Components

a. Description of Controls and Connections

BMA CTH

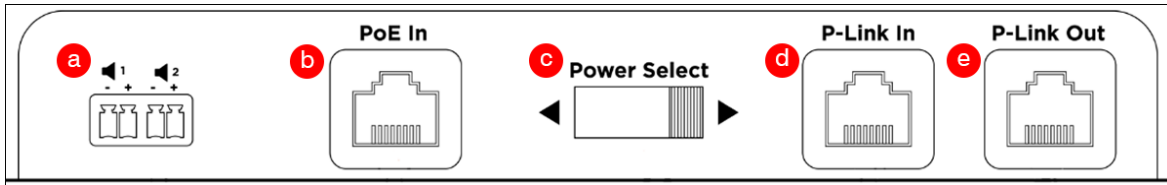

Figure 1. BMA-CTH Back Panel

	Description
a	Speakers Out. Two Phoenix Euroblock connectors for external 8 ohm speakers
b	PoE In: RJ45 connector. The Versa Lite CT does not use this connector. The Versa USB provides power to the BMA CTH through the P-Link In connector.
c	Power Select sliding switch. Position determines power source – either left for PoE In or right for P-Link In. With a Versa Lite CT, this switch is set to the right for P-Link In.
d	P-Link In: RJ45 connector. Receives power, audio, and control from the Versa USB.
e	P-Link Out: RJ45 connector. Connects to another P-Link device that requires power, such as a Bluetooth Expander.

Warning:

Power over Ethernet (PoE) equipment used with COLLABORATE® Versa Lite CT must meet the IEEE 802.3af or 802.3at standards.

You should use the PoE Power Injector provided with Versa Lite CT. Other power source equipment may immediately apply power and could damage the Versa Lite CT components.

Versa USB

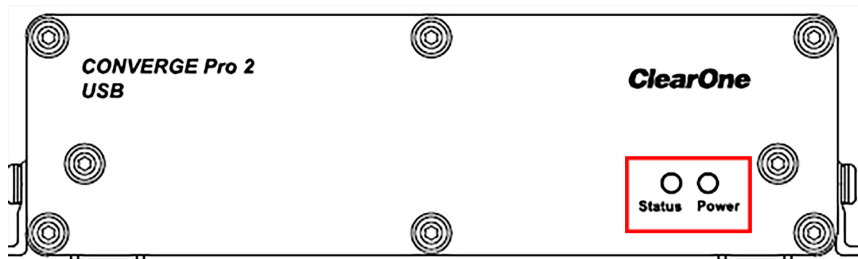

Figure 2. COLLABORATE Versa USB Front Panel

Status Indicator

LED Color	Meaning
Not lighted	No P-Link plugged in (attached?)
Solid Blue	P-Link plugged in; system working normally
Flashing Blue	Locate mode initiated from CONSOLE AI Lite
Solid Red	Error condition

Power Indicator

LED Color	Meaning
Not lighted	Off - not powered
Solid Blue	Powered

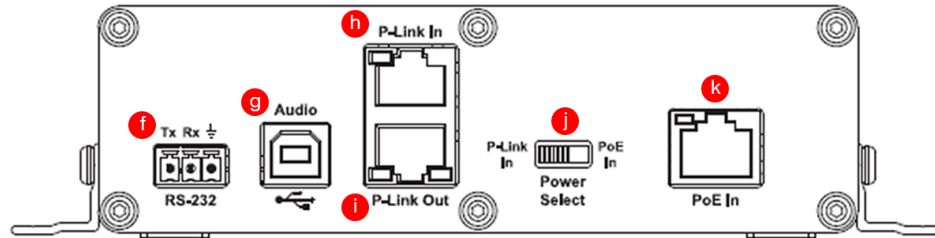

Figure 3. COLLABORATE Versa USB Back Panel

	Description
f	RS-232. Not used with Versa Lite CT.
g	USB Type B connector. Connects to Versa USB.
h	P-Link In. RJ45 connector. Not used with Versa Lite.
i	P-Link Out. RJ45 connector. Connects to BMA CTH.
j	Power Select sliding switch. Position determines power source – left for P-Link In or right for PoE in. With a Versa Lite CT, this switch is set for PoE In.
k	PoE In. RJ45 connector. Connects to the PoE Injector.

PoE Injector

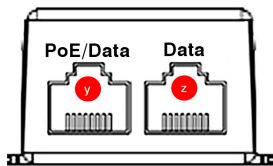

Figure 4. PoE Injector Connectors

	Description
y	RJ45 connector. Used to provide power to Versa USB
z	RJ45 connector. Not used.

b. Steps to Connect

In the following instructions, the letter references such as “(a)” refer to points on figures 1, 3, and 4.

Before you connect the devices, download CONSOLE AI Lite software from:

www.clearone.com/console-ai-lite-documents.

Step	Actions
1.	Complete this step NOW if you did not when you installed the BMA CTH. On the BMA CTH back plane: <ul style="list-style-type: none"> • With speaker wire (not included), connect the loudspeakers to the Phoenix Euroblock connectors (a) • Move the Power Select sliding switch (c) to the right, towards the P-Link In connector (d)
2.	On the Versa USB back panel Set the Power select switch (j) towards PoE In.
3.	With a 50 ft. CAT6 cable (provided) Connect the BMA CTH P-Link In connector (d) to the Versa USB P-Link Out connector (i).

Step	Actions
4.	<p>OPTIONAL</p> <p>If your system includes a Bluetooth expander (available separately), complete this step.</p> <p>If not, skip this step and proceed to step 5.</p> <p>With a CAT6 cable (not included),</p> <p>Connect the BMA CTH P-Link Out connector (e) to the Bluetooth Expander.</p>
5.	<p>With one of the included 25' CAT6 cables,</p> <p>Connect the Versa USB PoE In connector (k) to the PoE injector connector (y)</p>
6.	<p>With a USB cable, connect the Versa USB Audio connector (g) to a COLLABORATE Versa Hub (not included) or directly to the room PC or laptop.</p>
7.	<p>Caution: Complete this connection step only after you confirm that you correctly completed the previous steps!</p> <p>With the PoE Injector:</p> <ul style="list-style-type: none"> • Attach the power cord to the Power Supply. • Connect the power cord to a standard power outlet.

Step 4: Start and Test the System

Immediately after power is applied to the Versa Lite CT, the system uses **AutoConnect™** to recognize the system components, and **Audio Intelligence™** to set channel properties.

Launch your collaboration application (COLLABORATE Space, Microsoft Teams, Zoom, etc) and with someone located at a remote location, test the system.

Step 5: Adjust the System

Depending on the results of your test in step 4, you may need to adjust some system settings.

See the CONSOLE AI Lite User Manual, available at the ClearOne Resource Library at:

www.clearone.com/console-ai-lite-documents.

COLLABORATE Space Pro

COLLABORATE Space is a powerful collaboration application with a full suite of audio, video, and meeting tools in a persistent space.

Connect hundreds of users, unifying messaging, calling and meetings for cloud collaboration.

For more information, including instructions about how to use COLLABORATE Space, visit the ClearOne Resource Library at:

www.clearone.com/rl-home

and Browse by Solution in the CLOUD COLLABORATION section.



Pair a Bluetooth Device

To pair a device that has near-field communication (NFC) capabilities:

Tap the BT EX faceplate with the NFC-capable device.

This initiates a pairing between the device and the BT EX.

To pair a **non-NFC** device, complete the following steps:

1. On the front of the BT EX face plate, push the reset/pairing button.
2. In your Bluetooth-enabled device, navigate to your Bluetooth settings (e.g. for iOS users, Settings > Bluetooth).
3. Select "ClearOne Bluetooth xxxx" (xxxx indicates the last 4 digits of the MAC address).

When a device is **paired**, a short beep plays, followed by a **higher** frequency beep.

When a device is **unpaired**, a short beep plays, followed by a **lower** frequency beep.

Troubleshooting

Problem	Resolution
Microphone or speaker level is not correct	See the CONSOLE AI Lite User Manual, available at the ClearOne Resource Library at www.clearone.com/console-ai-lite-documents .
Audio to/from laptop or pc microphone/speaker	In Windows, Collaborate Space or other cloud-based collaboration application, adjust the Sound Device settings.
Audio with my cloud-based collaboration application is poor	Contact ClearOne Technical Support: Tel: 801.974.3760 e-mail: tech.support@clearone.com
Bluetooth connection does not work	See the Quick Start Guide for the ClearOne Bluetooth Expander, available at the ClearOne Resource Library at www.clearone.com/console-ai-lite-documents .
Undo my settings and revert to factory default	See the CONSOLE AI Lite User Manual, available at the ClearOne Resource Library at www.clearone.com/console-ai-lite-documents .

Compliance

Details about compliance for the BMA CTH and COLLABORATE Versa USB are available online on ClearOne's website (www.clearone.com) in the Resource Library.

ClearOne® Contacts

Headquarters

5225 Wiley Post Way
Suite 500
Salt Lake City, UT 84116

US & Canada

Tel: +1.801.975-7200
email: global@clearone.com

International

Tel: +1. 801.975.7200
email: global@clearone.com

Sales

Tel: +1.801.975.7200
email: sales@clearone.com

Technical Support

Tel: +1.801.974.3760
email: techsupport@clearone.com

© 2021 ClearOne, Inc. All rights reserved.

Information in this document is subject to change without notice.

Document: QSG-0091-001v1.2 May 2021